

8-1. 参看轴测图，补全三视图中所缺的图线。

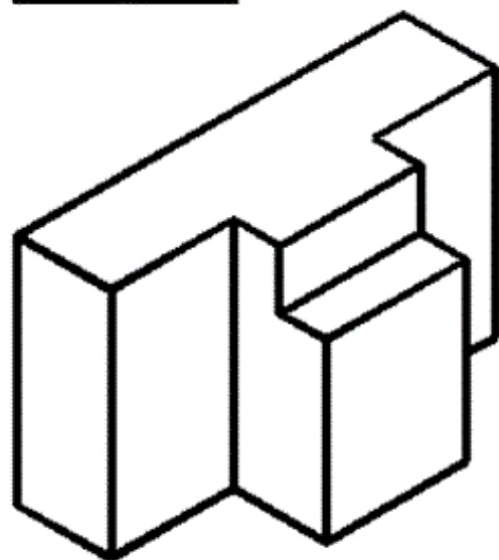

8-2. 参看轴测图，补全三视图中所缺的图线。

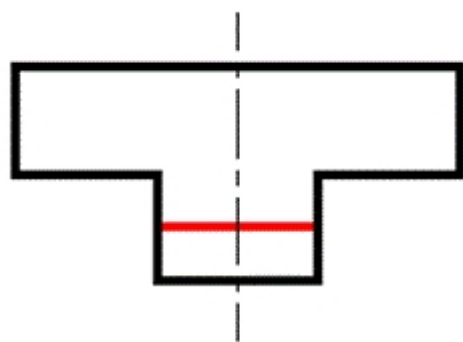
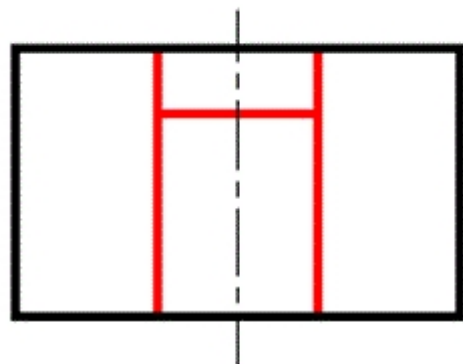
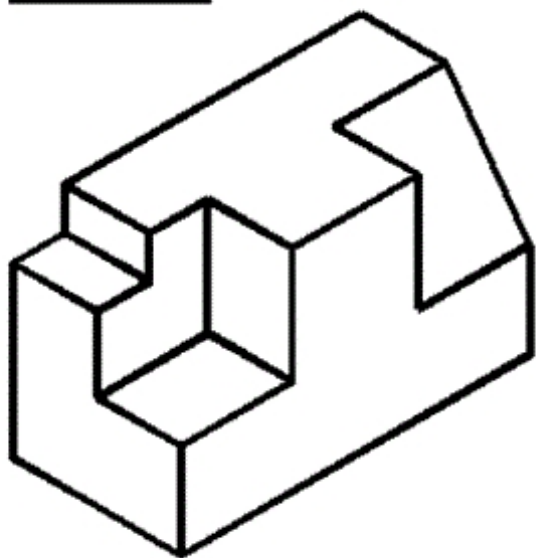
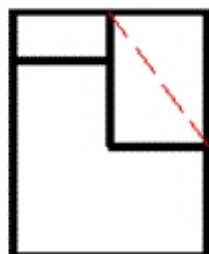
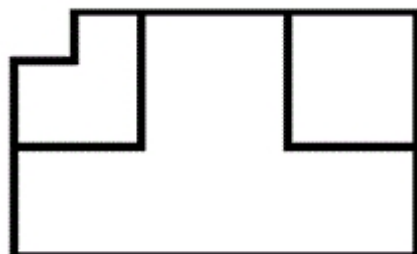

8-3. 参看轴测图，补全三视图中所缺的图线。

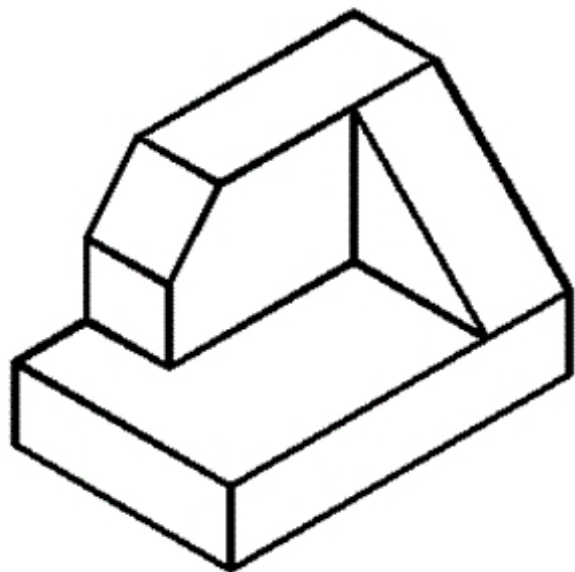
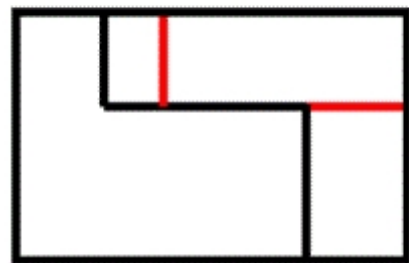
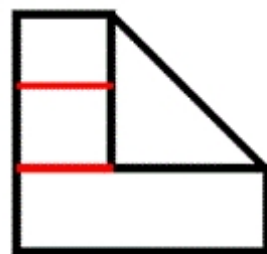
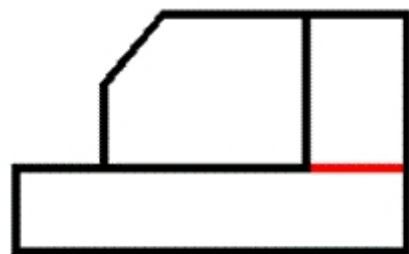

8-4. 参看轴测图，补全三视图中所缺的图线。

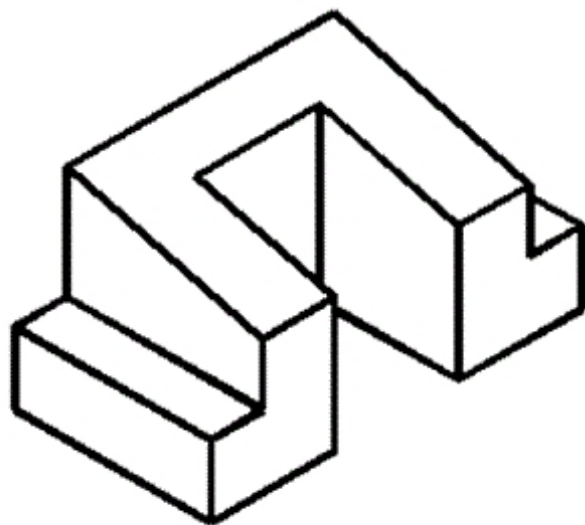
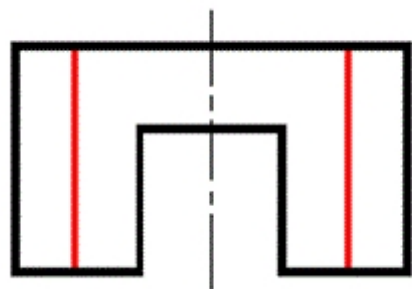
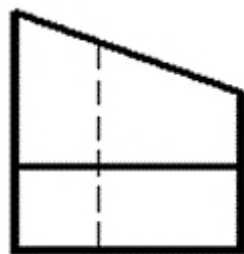
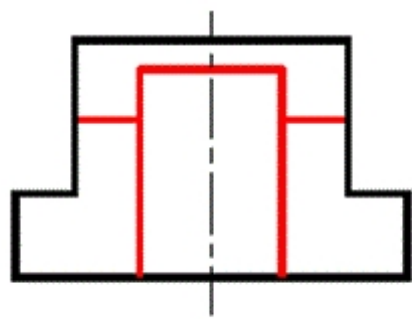

8-5. 参看轴测图，补全三视图中所缺的图线。

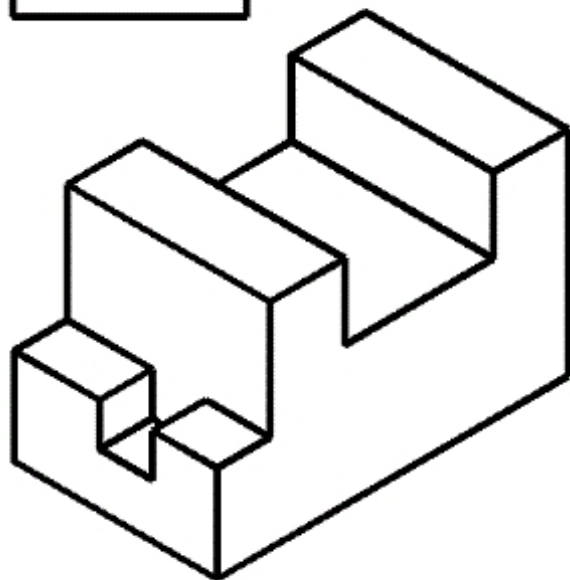
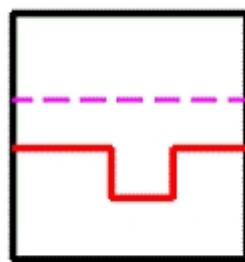

8-6. 参看轴测图，补全三视图中所缺的图线。

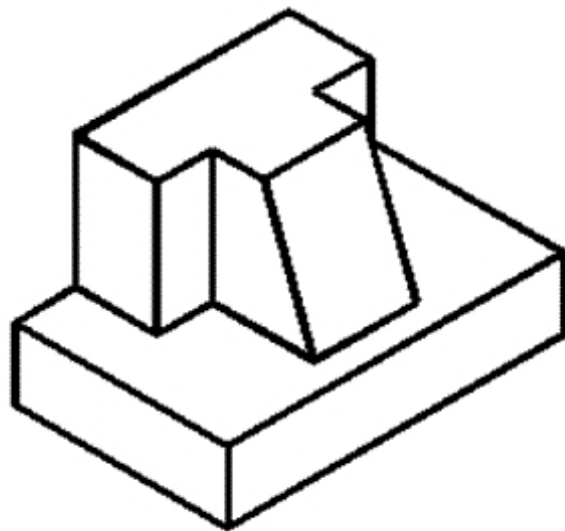
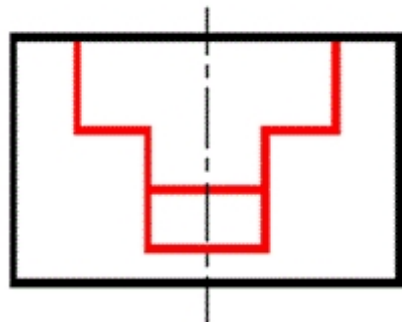
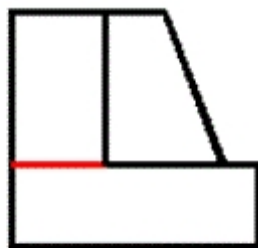
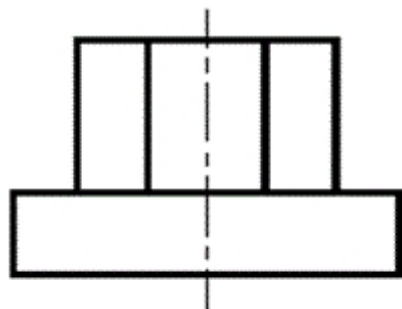

9-1. 参看轴测图，补全三视图中所缺的图线。

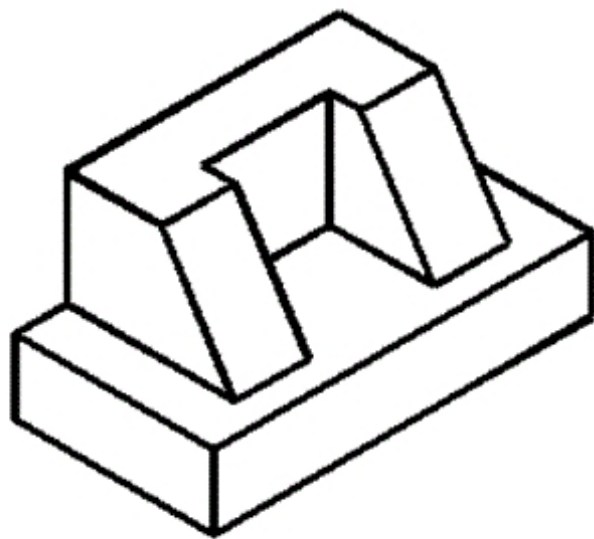
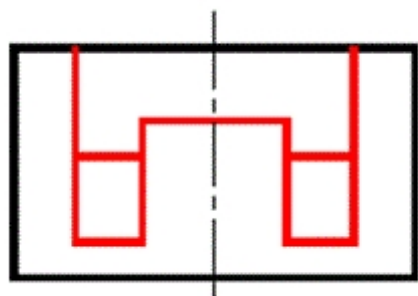
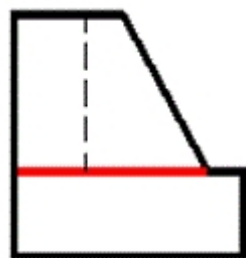
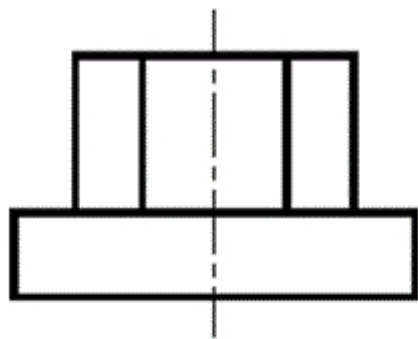

9-2. 参看轴测图，补全三视图中所缺的图线。

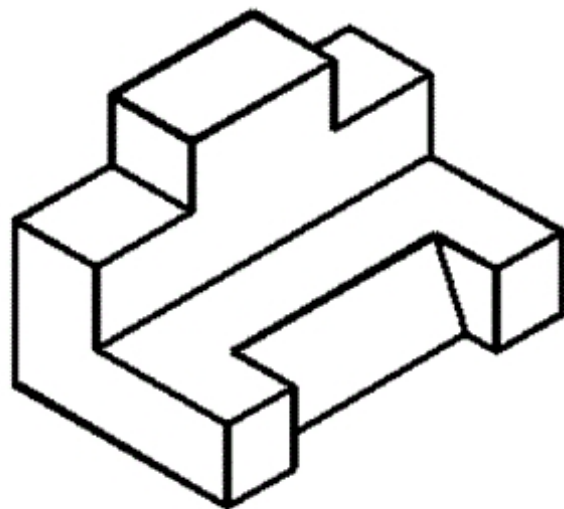
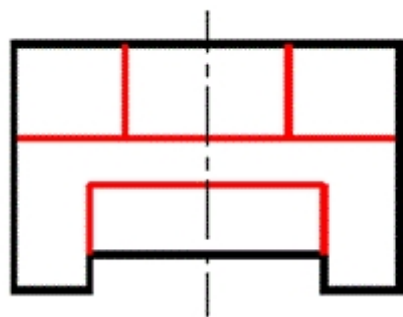
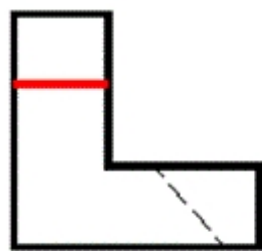
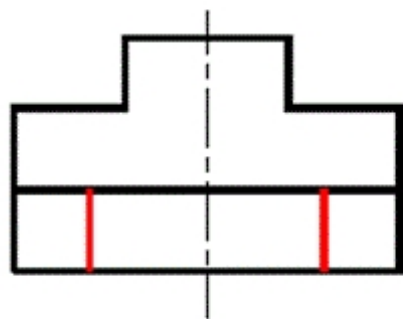



9-3. 参看轴测图，补全三视图中所缺的图线。

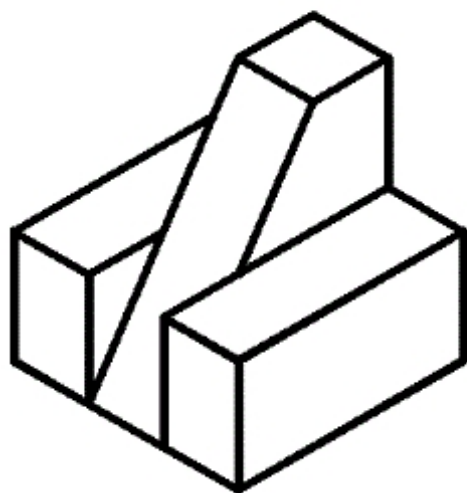
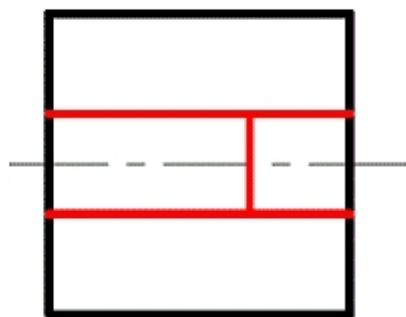
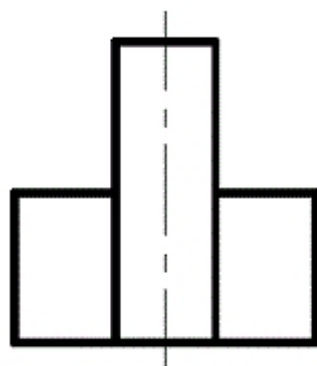
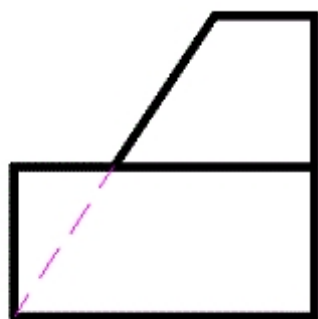

9-4. 参看轴测图，补全三视图中所缺的图线。

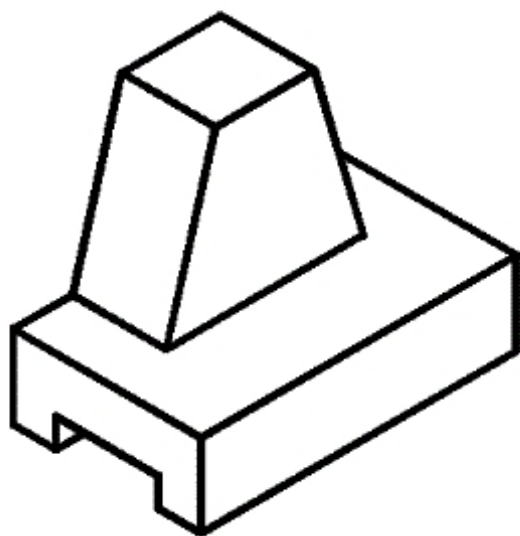
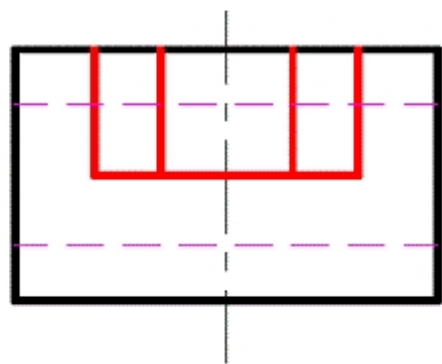
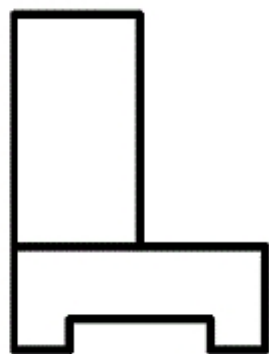
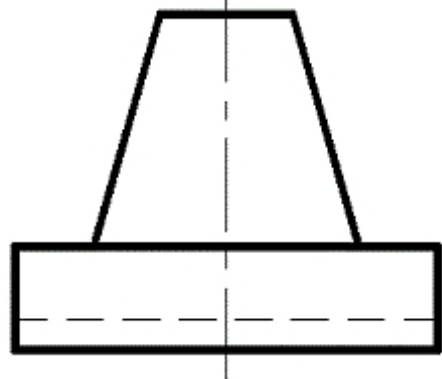

9-5. 参看轴测图，补全三视图中所缺的图线。

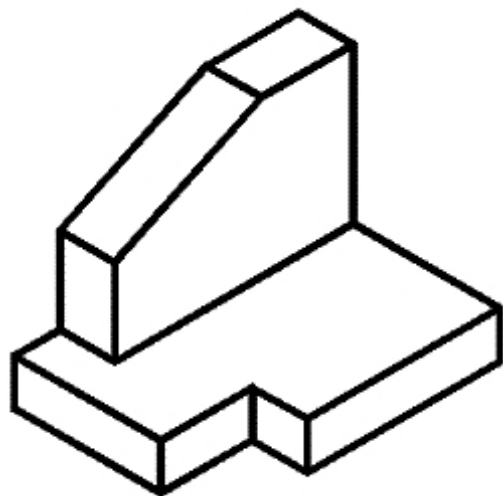
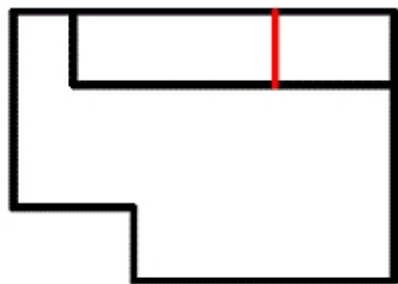
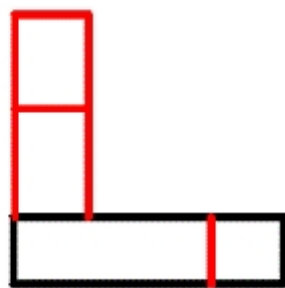
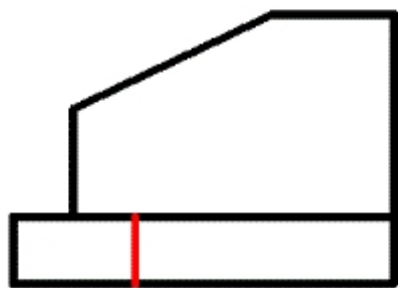

9-6. 参看轴测图，补全三视图中所缺的图线。

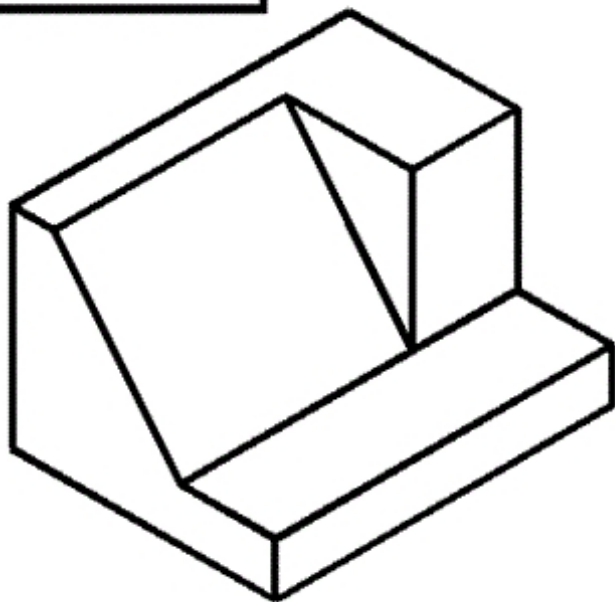
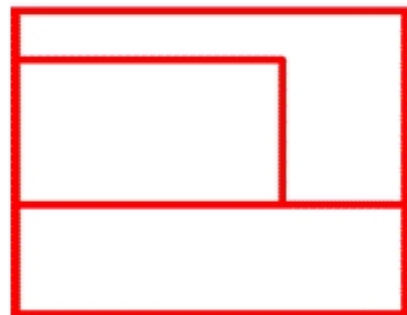
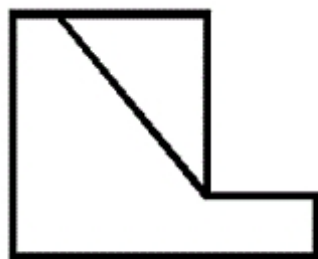
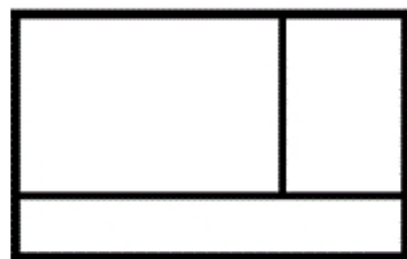

10-1. 参看轴测图，画出物体第三视图。

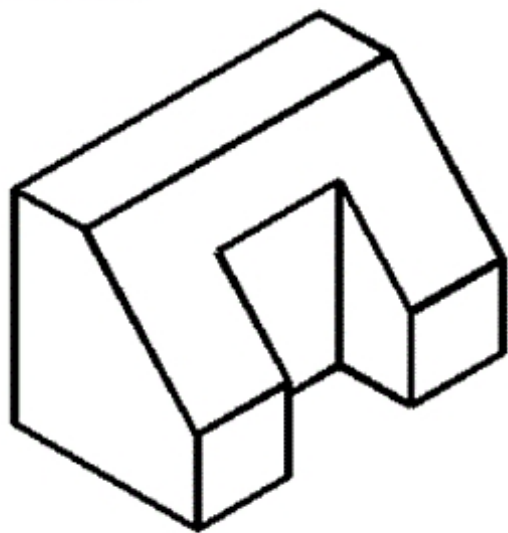
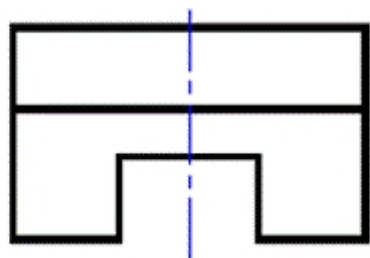
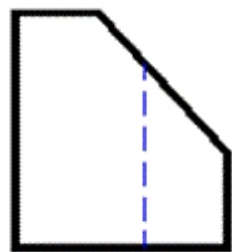
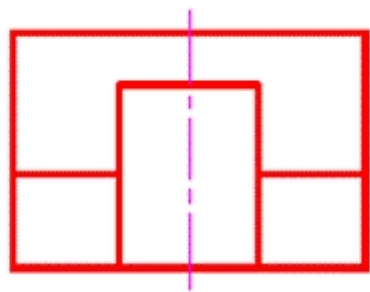

10-2. 参看轴测图，画出物体的第三视图。

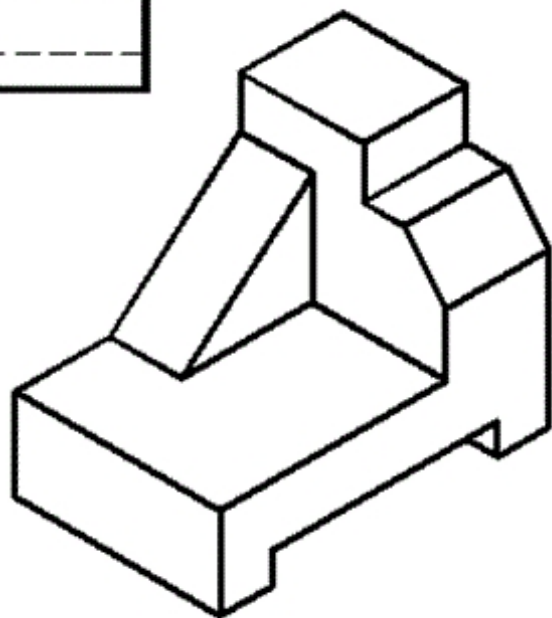
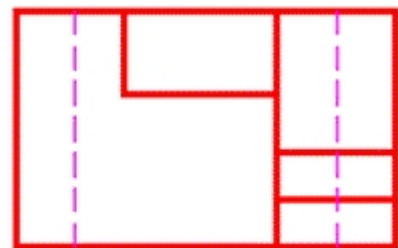
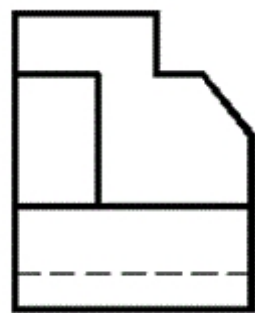
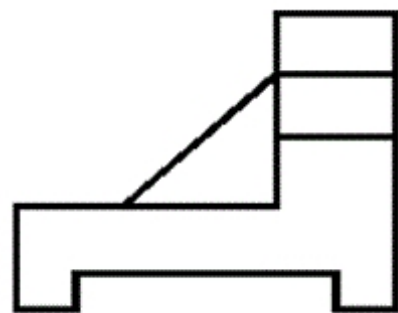

10-3. 参看轴测图，画出物体的第三视图

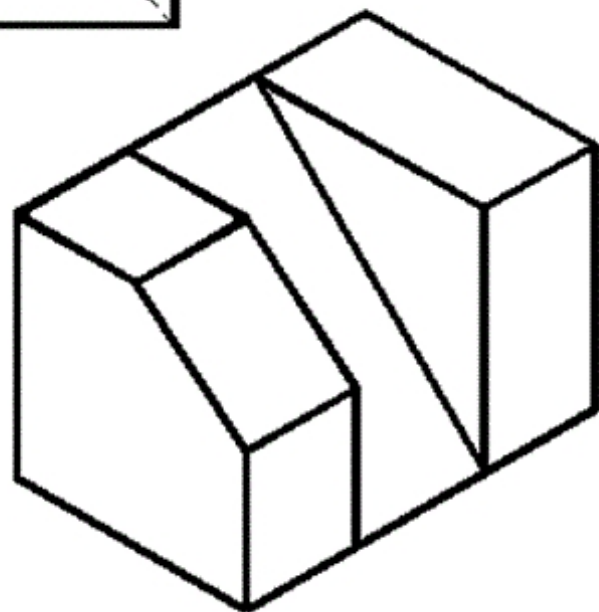
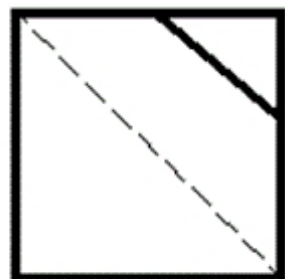

10-4. 参看轴测图，画出物体的第三视图。

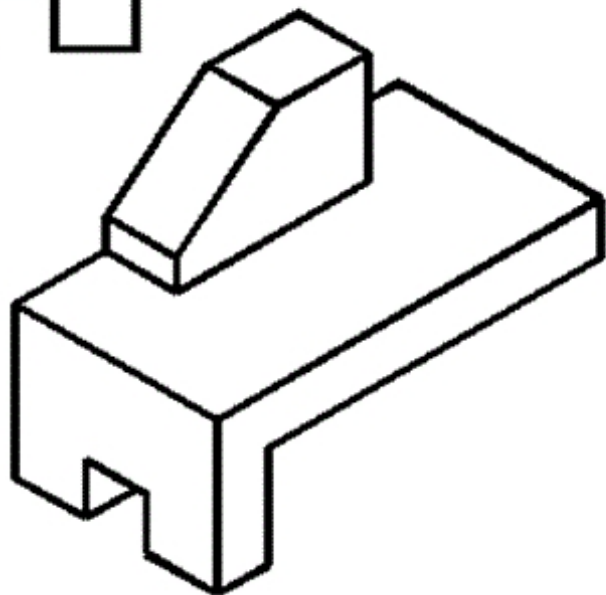
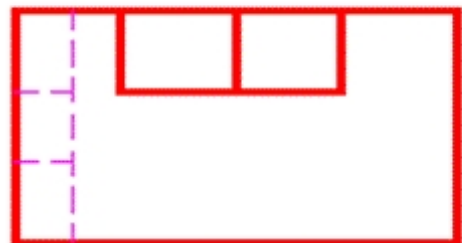
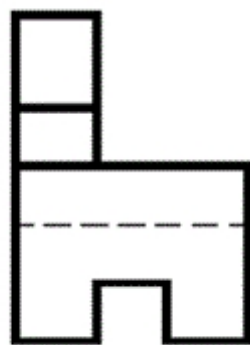
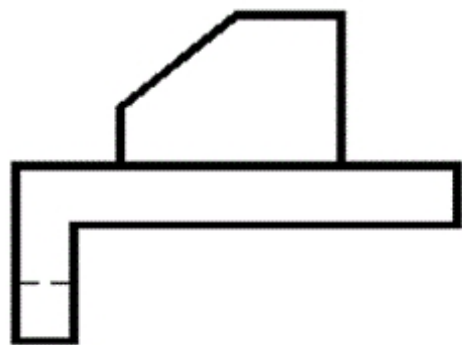



10-5. 参看轴测图，画出物体的第三视图

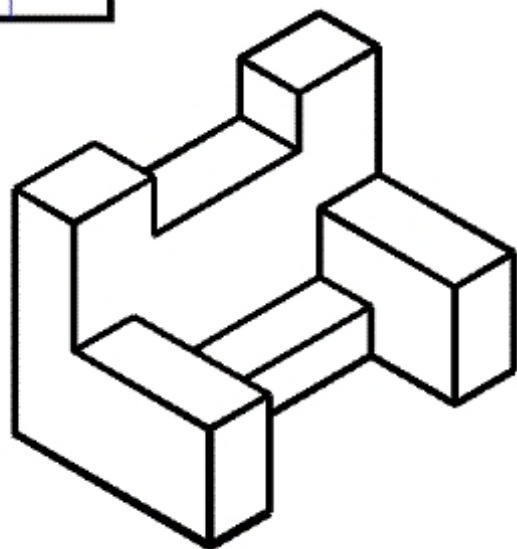
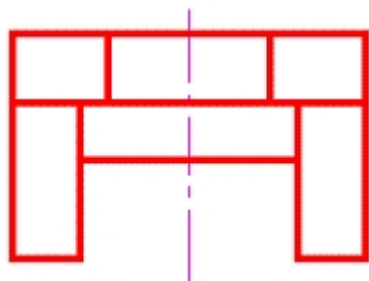
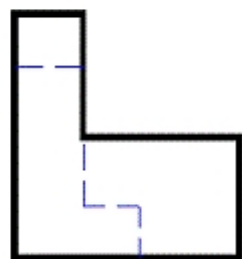
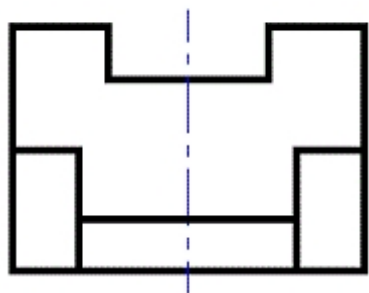

10-6. 参看轴测图，画出物体的第三视图

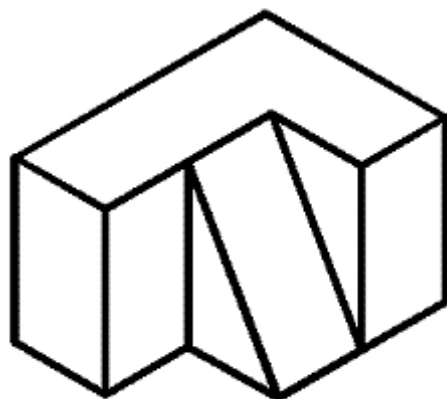
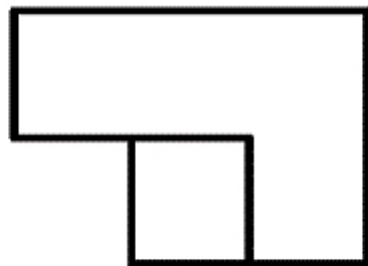

11-1. 参看轴测图，画出物体的其它二个视图。

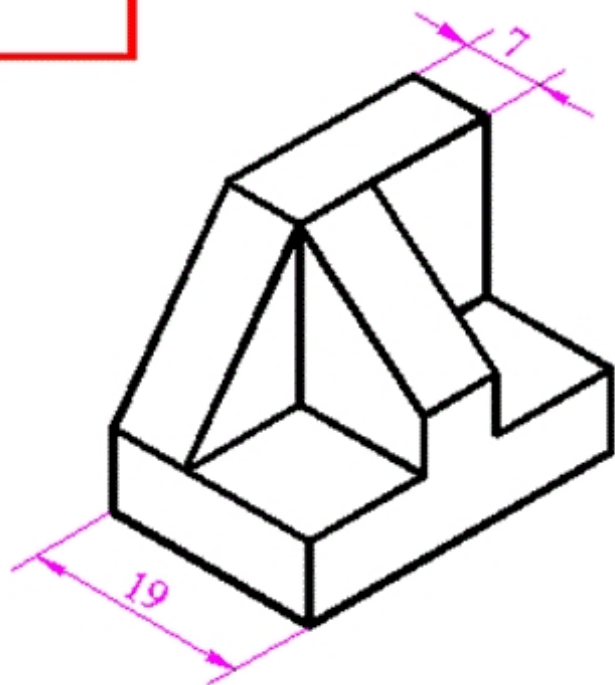
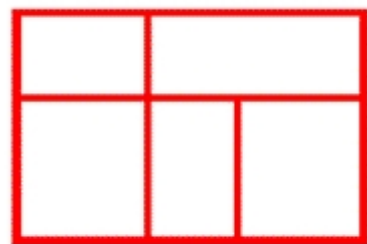
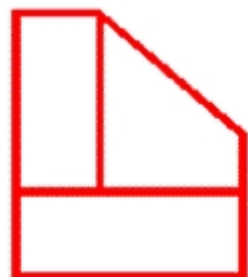

11-2. 参看轴测图，画出物体的其他两个视图。

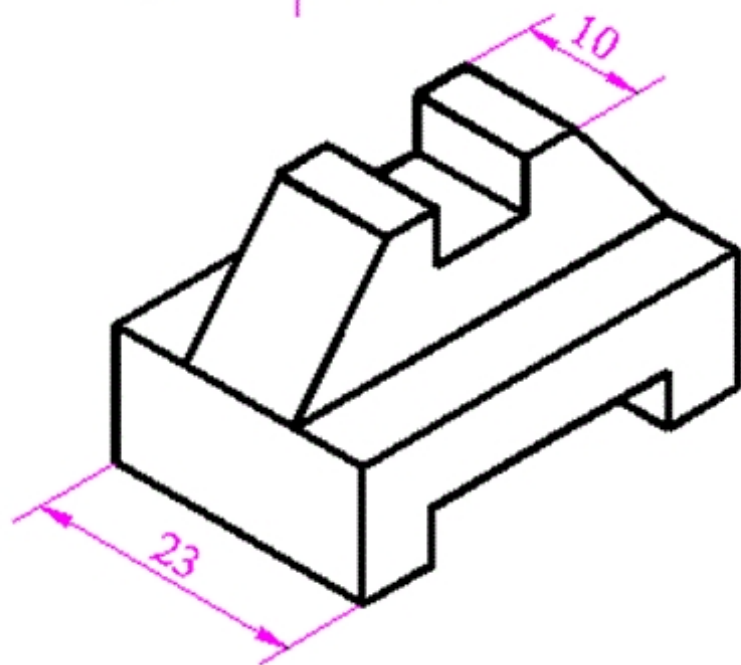
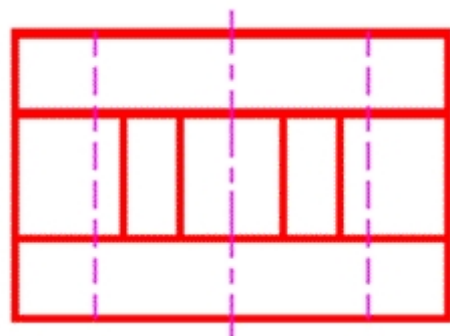
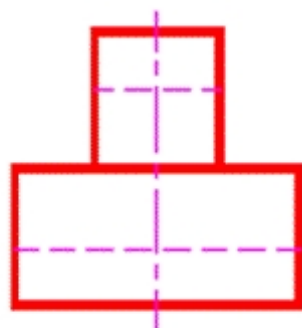
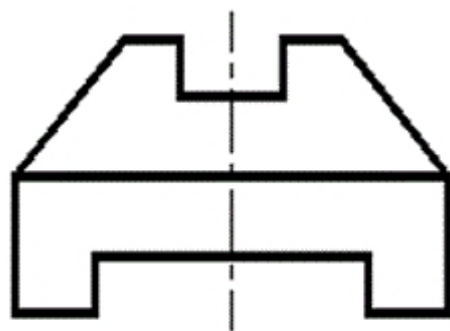

11-3. 参看轴测图，画出物体的其它两个视图。

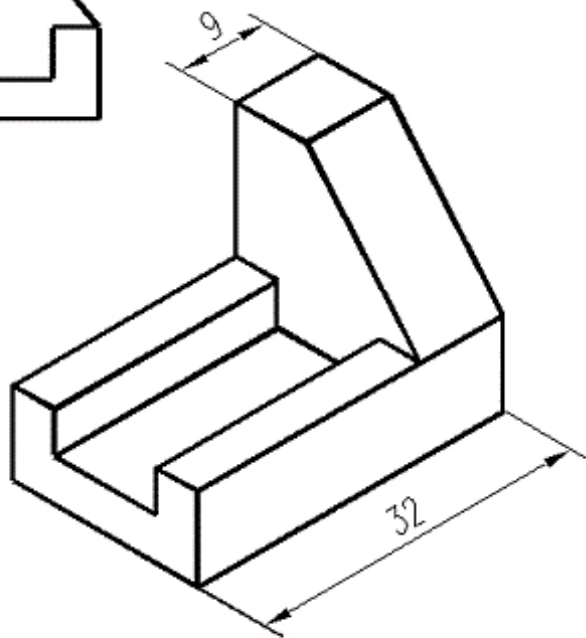
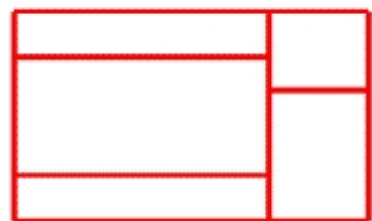
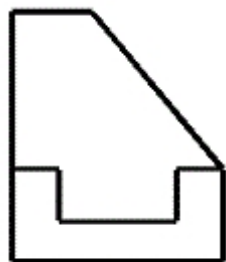
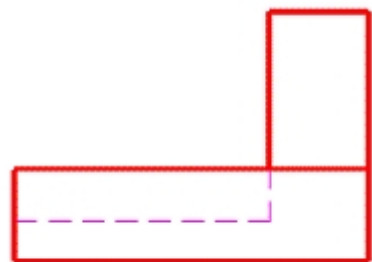

11-4. 参看轴测图，画出物体的其它二个视图。

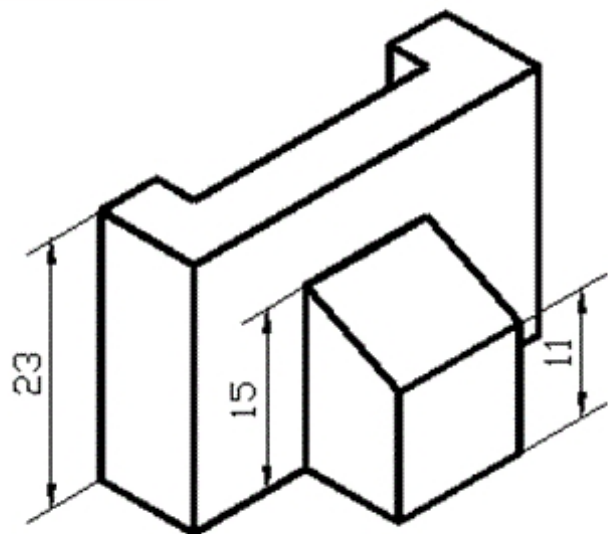
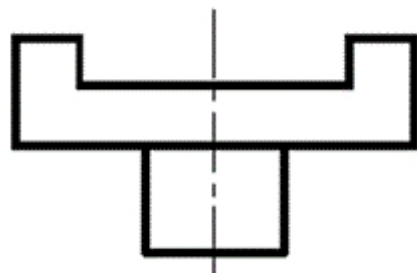
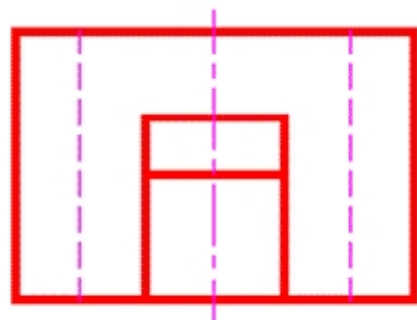

12-1. 补画第三视图及立体表面上点、线的投影  
(不可见点加括号)。

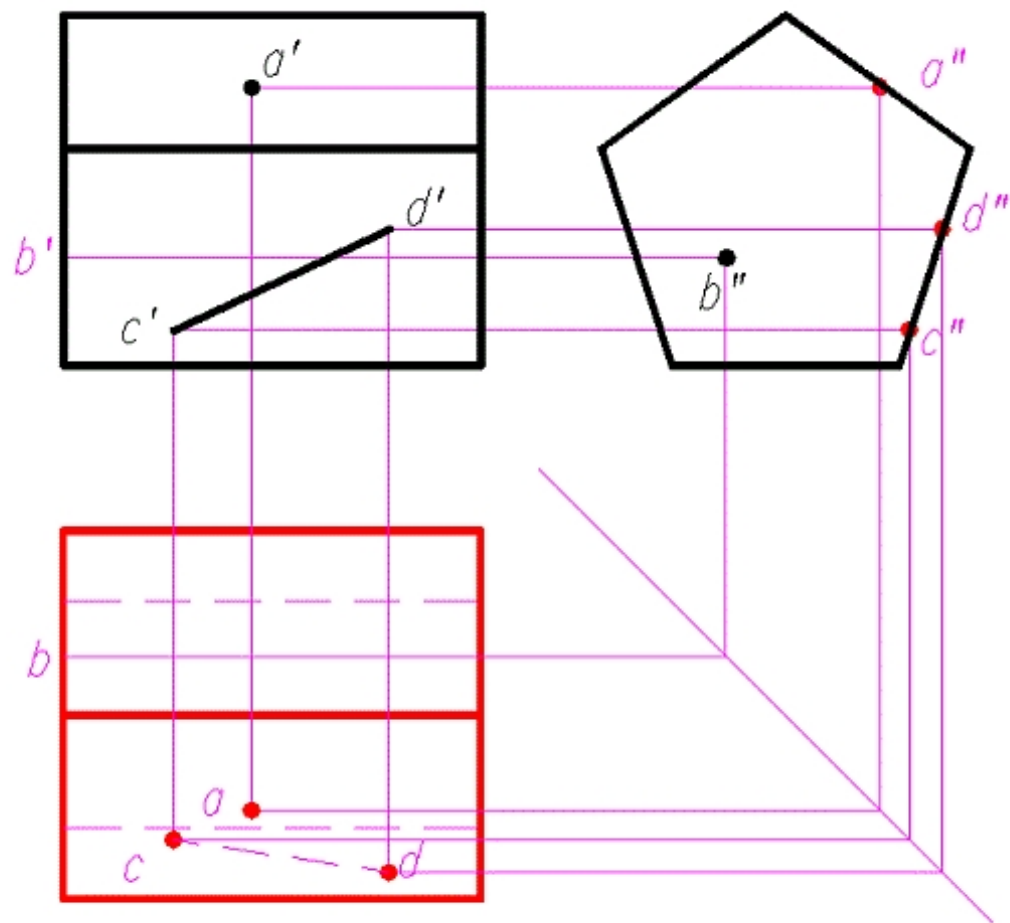

12-2. 补画第三视图及立体表面上点、线的投影  
(不可见点加括号)。

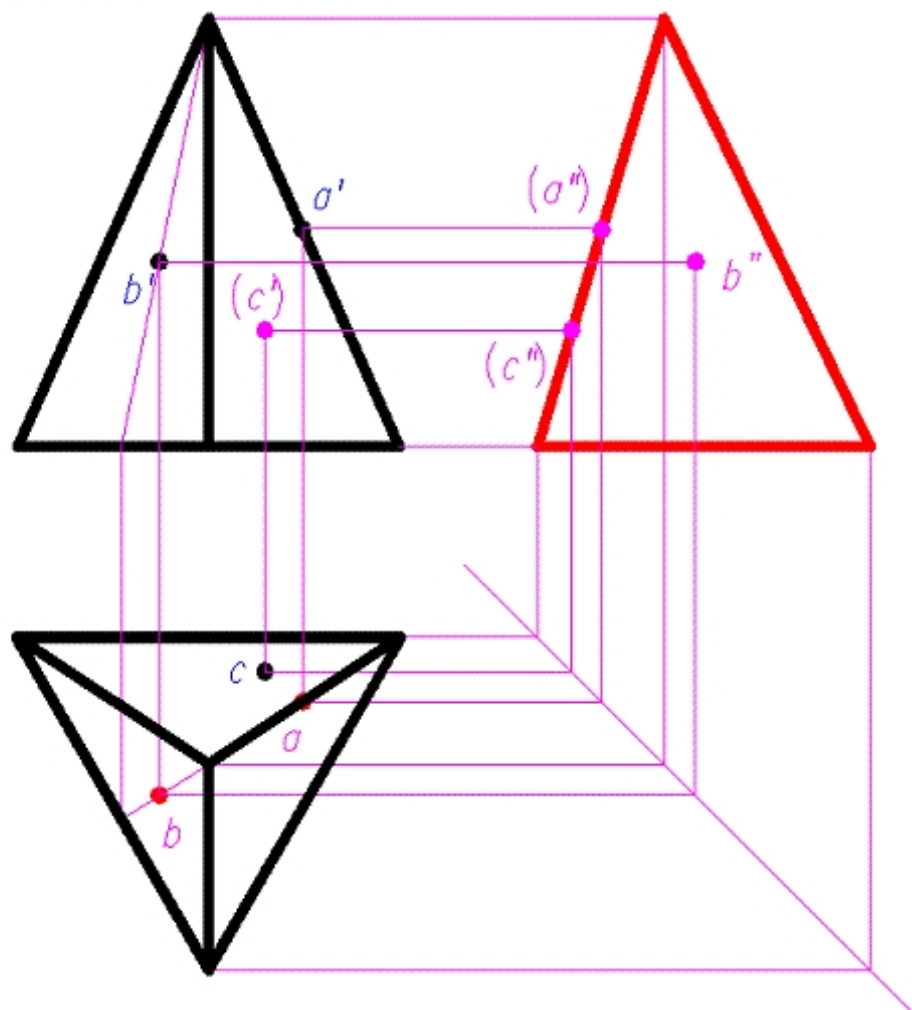



12-3. 补画第三视图及立体表面上点、线的投影  
(不可见点加括号)。

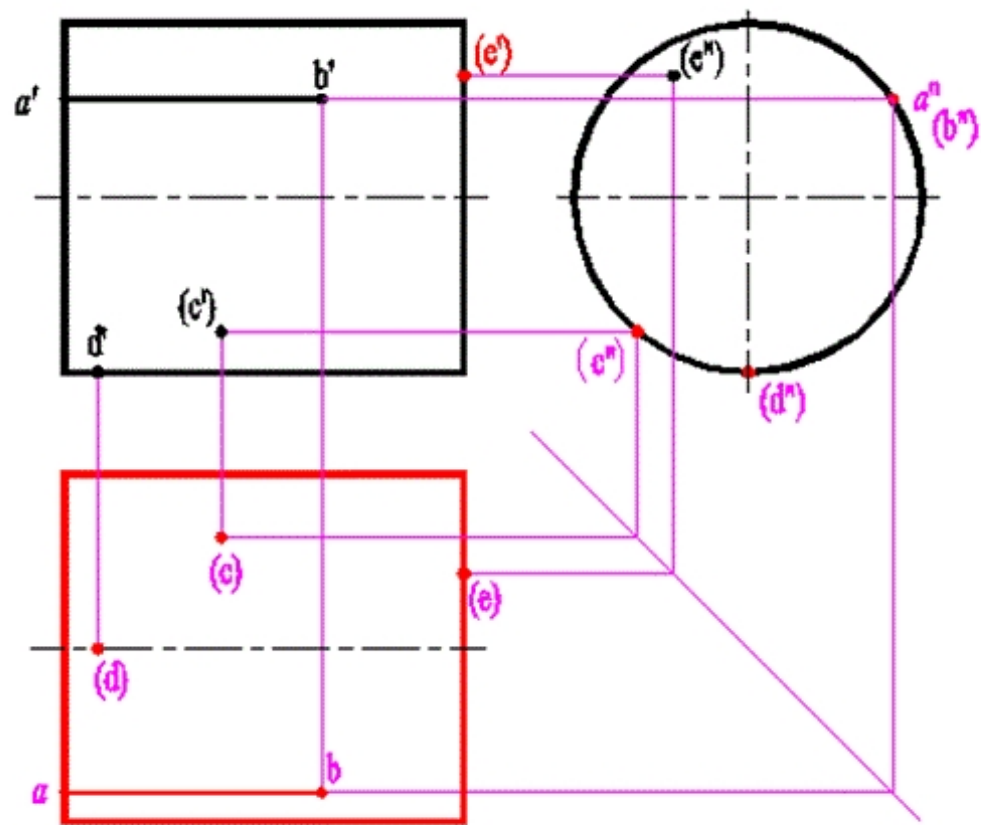

12-4. 补画第三视图及立体表面上点、线的投影  
(不可见点加括号)。

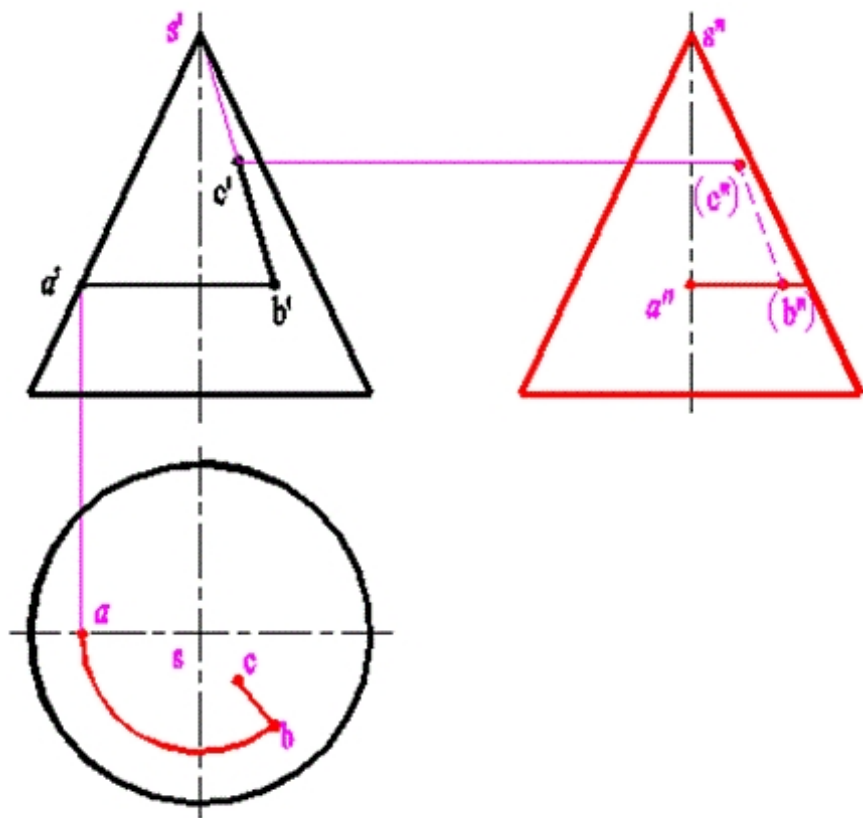

12-5. 补画第三视图及立体表面上点、线的投影  
(不可见点加括号)。

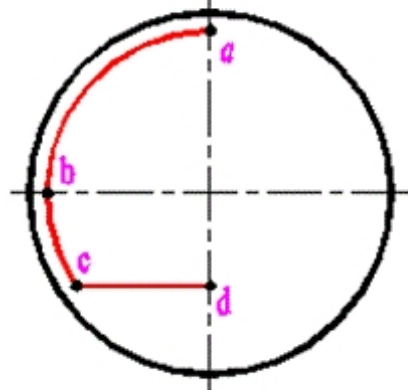
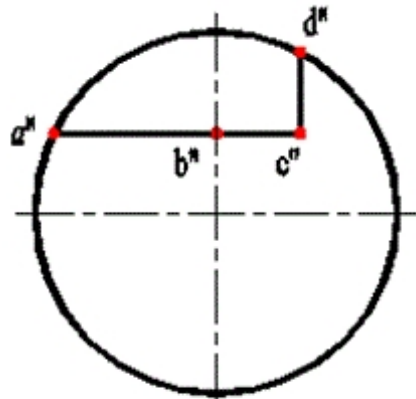
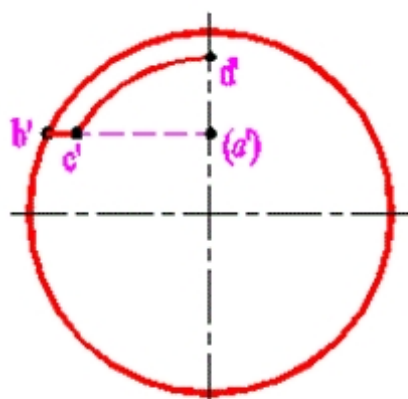

12-6. 补画第三视图及立体表面上点、线的投影  
(不可见点加括号)。

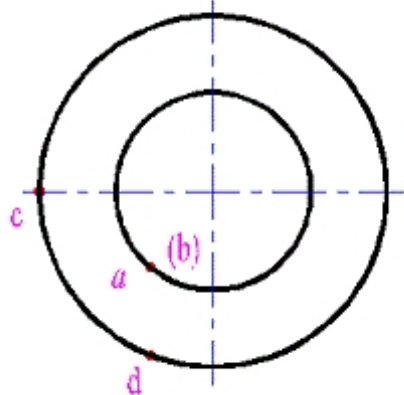
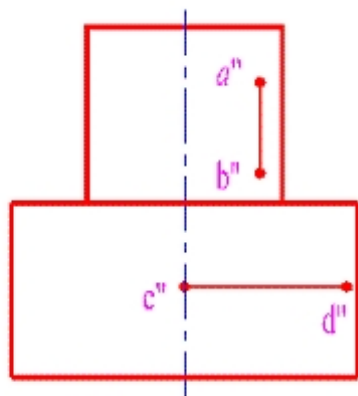
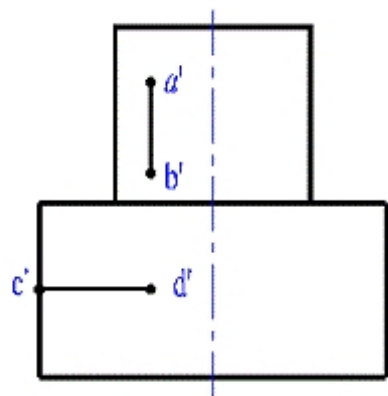

13-1. 根据轴测图，画出物体的另外二个视图。

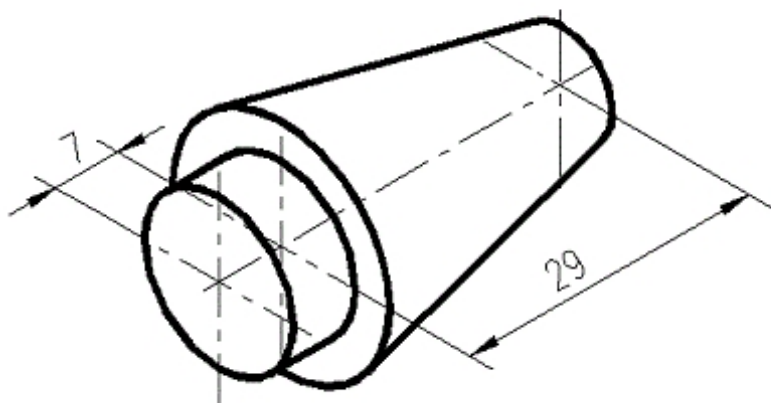
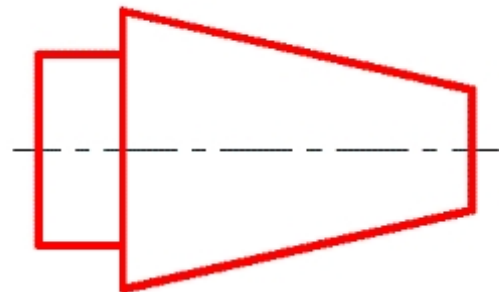
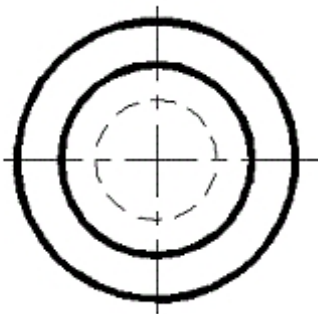
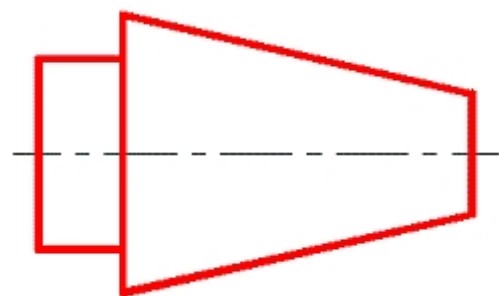

13-2. 根据轴测图，画出物体的另外二个视图

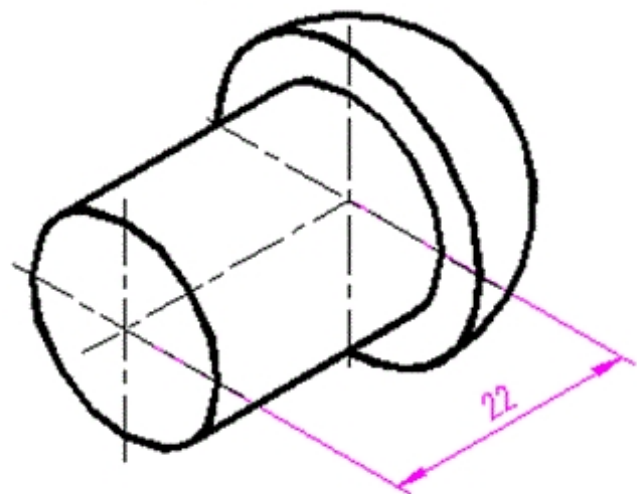
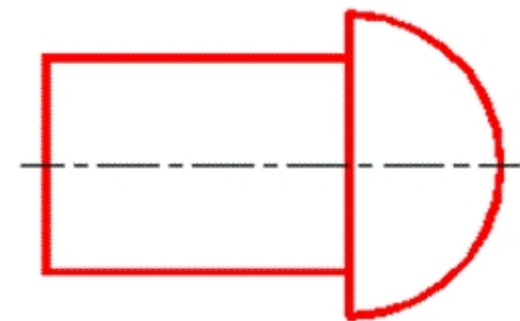
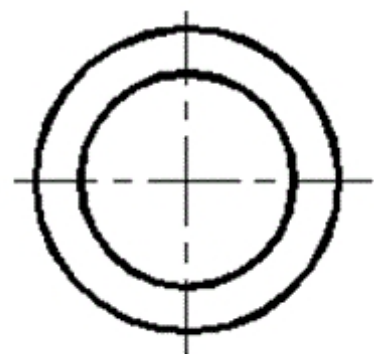
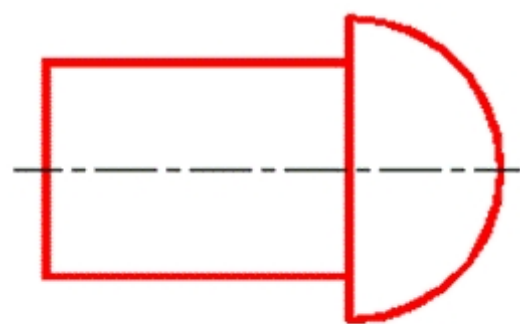

13-3. 根据轴测图，画出物体的另外二个视图。

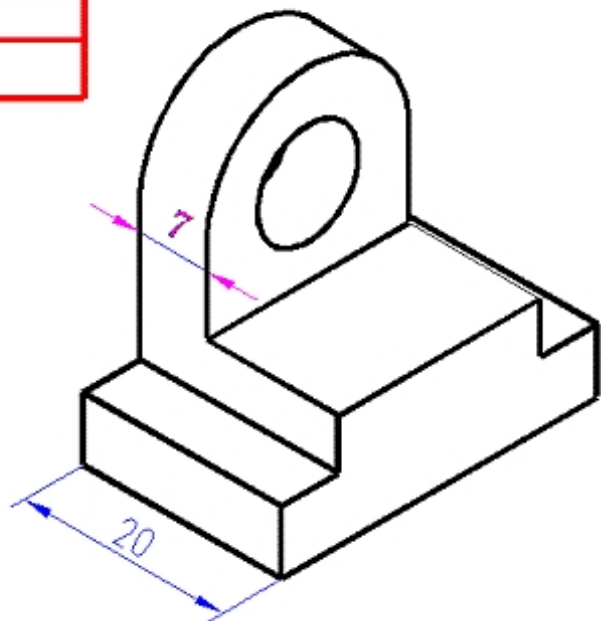
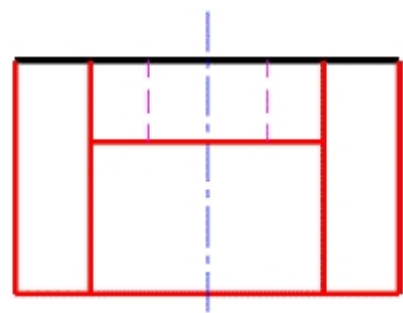
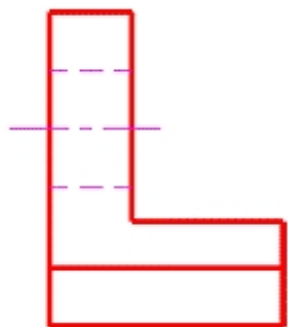
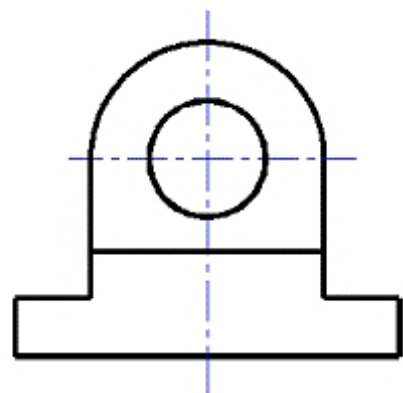

13-4. 根据轴测图，画出物体的另外二个视图。

